

# ULTRA HIGH EFFICIENCY TRI GENERATION COMBINED HEAT AND POWER

- Tri-Generation CHP**  
 Cheap, efficiency electricity  
 Ultra-high thermal efficiency  
 + Steam  
 + Hot water  
 + Cooling down to 3°C  
 + Significantly reduced energy bill  
 + Reduced overall energy consumption  
 + Significantly reduced emissions  
 + Reduced carbon footprint  
 + Solar boost ready

**ELECTRICITY OUT**  
all year round

**Combine Cycle  
Gas & Steam Turbine  
Generator**

Surplus  
Steam

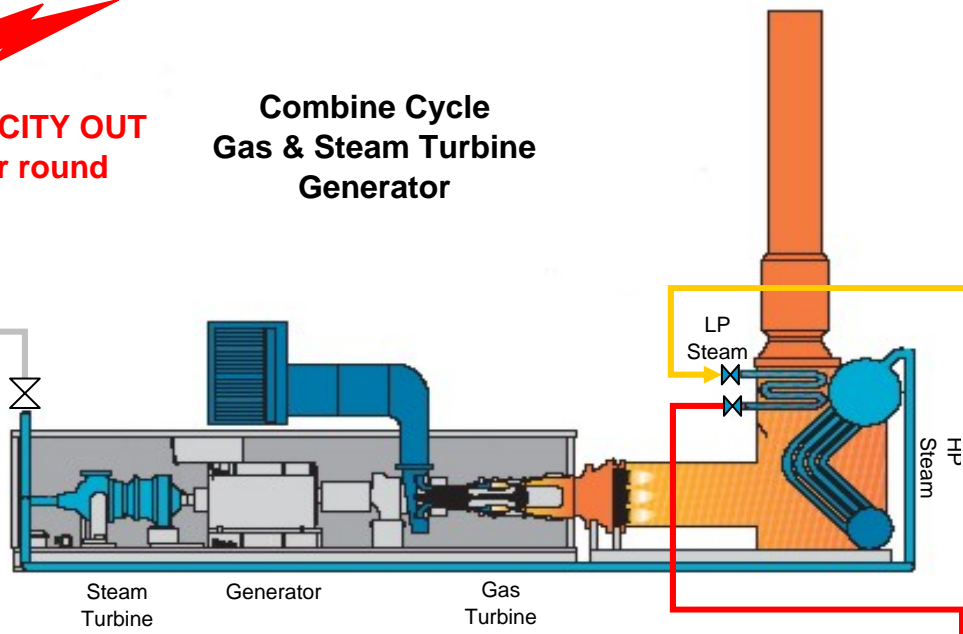

**COOLING  
in Summer**

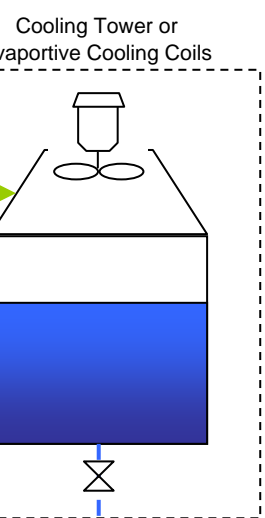
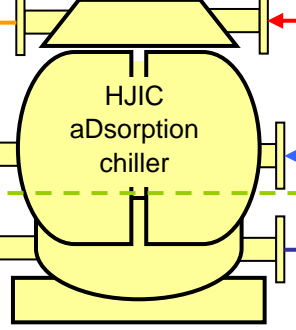
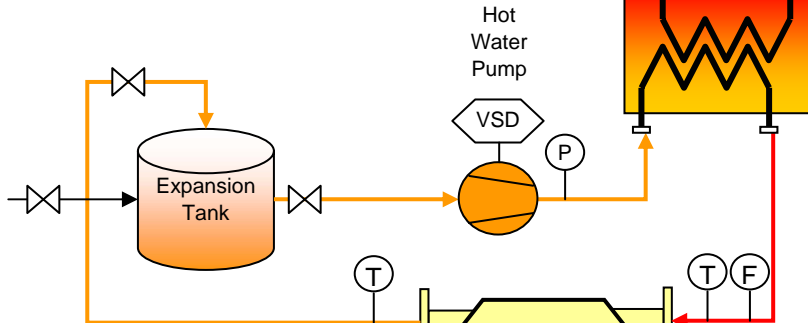
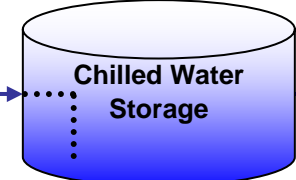
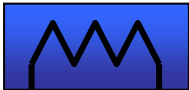

**HOT WATER to:**  
Bathrooms,  
Showers, Kitchens,  
Laundry, Spa,..

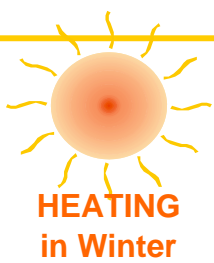

**HEATING  
in Winter**

Heat rejected to Ocean, River or Lake.  
**ELIMINATES COOLING TOWERS**



**SOLAR BOOST READY**

